

ordro[®]

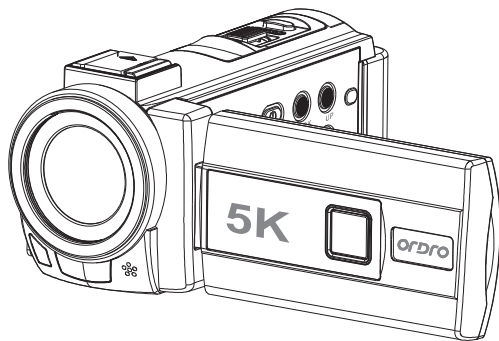

HDR-AE20 User Manual

Contents

Important notice.....	1
1 About the camera.....	3
1.1 Computer System Requirements.....	3
1.2 Diagrams of the camera.....	3
1.3 Description of button functions.....	5
2 Preparation for use.....	6
2.1 Insert a memory card.....	6
2.2 Mount a battery.....	7
2.3 Charge the battery.....	7
2.4 Power on/off the camera.....	8
2.5 Change working mode.....	8
2.6 Use the Remote control.....	8
2.7 Connect to a computer.....	8
2.8 Connect to a TV.....	8
2.9 Use an external microphone	9
2.10 Use the Zoom function.....	9
2.11 Use the IR night vision	9
2.12 Use the LED light.....	9
3 Use the camera.....	10
3.1 Video mode.....	10
3.2 Photo mode.....	13
3.3 Playback Mode.....	16
4 System Menu.....	17
4.1 WiFi.....	17
4.2 Date&Time.....	17

Contents

4.3 Auto Power Off.....	17
4.4 Beep Sound.....	17
4.5 Language.....	18
4.6 Frequency.....	18
4.7 WiFi Auto Off.....	18
4.8 Format.....	18
4.9 Default Setting.....	18
4.10 Version.....	18
5 Wi-Fi Connection.....	19
6 Appendices.....	20
6.1 Technical Specifications.....	20
6.2 Common faults and solutions.....	21

Important notice

Safety Information

- ◇ Please read this instruction carefully to get the best use effect.
- ◇ Please supervise children, do not let children use the camera alone.
- ◇ It is prohibited to use the camera near fire sources, such as candles, heat sources, radiators, and stoves.
- ◇ The camera and charger will heat up when they are working, please keep them ventilated and any covering is prohibited.
- ◇ It is forbidden to charge for a long time, and it is forbidden to charge during lightning, otherwise it may damage the camera or cause an accident.
- ◇ If the camera is damaged, flooded or short-circuited, please turn off the camera immediately and take out the battery.

Battery and LCD screen warnings

- ◇ Battery is a chemical product and incorrect use may cause fire or accident.
- ◇ When not in use for a long time, please take out the battery and place it in a dry place. Do not store or use in high temperature locations.
- ◇ It is prohibited to short-circuit, hit, squeeze, puncture, disassemble or incinerate the battery. Do not use swollen or leaking batteries.
- ◇ The LCD screen is fragile and is not allowed to be dropped, squeezed or knocked. If the screen is broken, do not touch it. In case of accidental contact, rinse immediately with clean water. If swallowed accidentally, rinse mouth immediately and drink plenty of water. Seek medical attention immediately.

Important matters

- ◇ It is prohibited to expose the camera to direct sunlight for a long time.
- ◇ Do not use or store in places with strong vibrations.
- ◇ It is prohibited to use corrosive solvents to clean the camera and accessories. Please use a clean soft cloth to clean.
- ◇ Using environment: temperature -10°C~50°C (14°F~122°F), humidity ≤60%, dust-proof.
- ◇ Storage environment: Temperature -20°C~60°C (-4°F ~140°F), humidity ≤50%, dust-proof.
- ◇ It is prohibited to disassemble the camera by yourself. If you disassemble it by yourself, you will lose the warranty qualification. In case of malfunction, please ask professionals to handle it.

Important notice

Other warnings

- ◇Cameras with Wi-Fi or Bluetooth may interfere with aircraft, medical equipment, etc. Please do not use them where prohibited by law.
- ◇Please abide by the local laws and regulations on the use of wireless devices.
- ◇Please abide by local laws and regulations on personal privacy protection.
- ◇It is forbidden to throw away the camera and accessories at will, please dispose of it reasonably according to local laws.

Check before use

Please take a test shot before use to ensure the camera is working properly. We are not responsible for additional losses caused by incorrect use or malfunction.

Copyright and Trademark

Microsoft/windows is a registered trademark of Microsoft Corporation.

Pentium is a registered trademark of Intel Corporation.

Macintosh/Mac OS/iOS are registered trademarks of Apple Inc.

Android is a registered trademark of Google Inc.

The product names, terminology or trademarks referenced are the registered trademarks of their respective relevant owners.

About the manual

- ◇Pictures are for reference only. We strive to keep the content correct. If the product is updated, please refer to the actual product.
- ◇In order to improve user experience, the APP may be upgraded, please refer to the actual situation for use without prior notice.
- ◇We reserve all rights to this manual. No company or individual may copy or disseminate without our consent.

1 About the camera

Thanks for choosing this product!

This is a 5K UHD digital video camera that supports Wi-Fi wireless applications, with the following features:

- ◇ 5K UHD video
- ◇ 56MP photo
- ◇ 3.0-inch IPS screen
- ◇ Smart touch
- ◇ IR night vision
- ◇ Slow motion recording
- ◇ Loop recording
- ◇ Time-lapse
- ◇ EIS anti-shake
- ◇ Wi-Fi, mobile APP
- ◇ IR remote control
- ◇ Support external microphone
- ◇ Support up to 256GB memory card

1.1 Computer System Requirements

When using the camera with a computer, the computer must not fall below the following specifications:

CORE i3/3.0G or above processor/Windows XP or above operating system

8GB or more memory/2GB or more graphics card/500GB or more available disk space

Standard USB2.0 or higher interface/1920x1080 pixel or higher screen resolution.

If the computer specification is low, it may not work properly when connected to the camera.

1.2 Diagrams of the camera

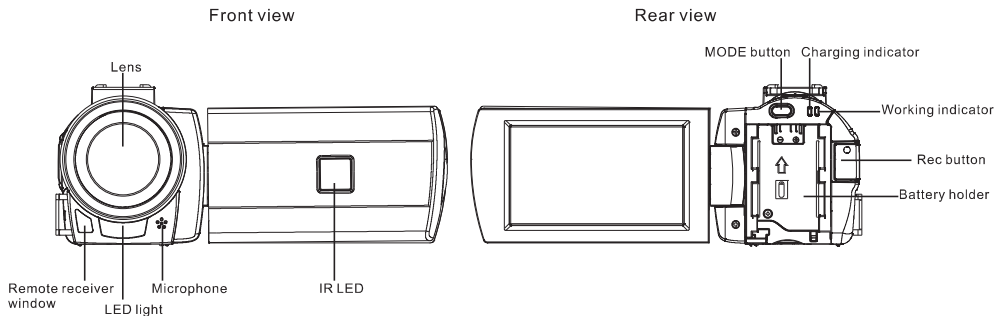

1 About the camera

Top view

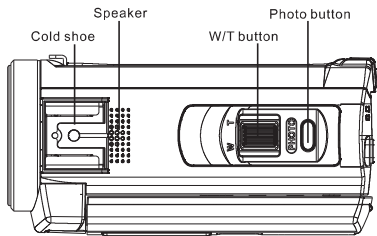

Bottom view

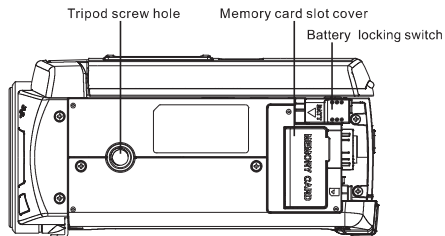



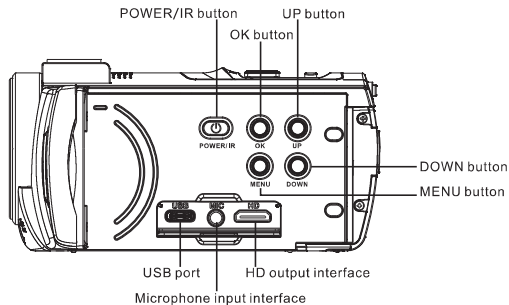





Left side view



1 About the camera

1.3 Description of button functions

Icon	Button name	Function Description
	<POWER/IR>	Short press to power On, Long press to power Off. After powering on-short press to turn On IR night vision; press again to turn On LED light; press again to turn Off LED light.
	<OK>	Confirm operation
	<UP>	Move Forward/Upward Adjust the EV value during preview or recording When playing back a video- Rewind
	<MENU>	Enter menu, Return (without saving) Long press to turn Wi-Fi On/ Off
	<DOWN>	Move Backward/ Downward During preview or recording, Short press to adjust the EV value, and Long press to clear the screen display parameters. When playing back a video- Fast forward
	<W/T>	Zoom, zoom In/Out Adjust the volume while playing a video
	<PHOTO>	In Photo mode- press Lightly to Focus, press Hard to Take photo
	<MODE>	Change working mode- Photo mode/Video mode/ Playback mode
	<REC>	In Video mode- Record video/Stop recording video When playing back a video- Play/Pause

Note: The place with < > means a button or switch of the camera.

2 Preparation for use

2.1 Insert a memory card

It needs to insert a memory card into the camera, please follow the figure as shown below.

2.1.1 Open the memory card slot cover. Insert the memory card in the direction as shown in the figure, and push until you hear a "click".

2.1.2 Close the memory card slot cover.

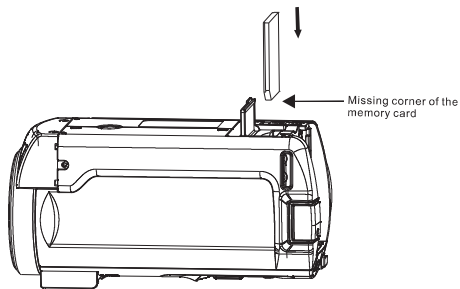

Use a qualified memory card of U3 or above and format it with the camera. Some memory cards may cause the camera to work abnormally, please pay attention to the compatibility. Do not insert or remove the memory card during work, as this will damage the memory card or lose data.

2 Preparation for use

2.2 Mount a battery

Please mount the lithium battery correctly before use, as shown in the figure below.

2.2.1 Make sure the metal contacts of the lithium battery toward the charging indicator light CHG, then align the battery with the arrow mark on the battery mount and cover it, then press the battery.

2.2.2 Push the battery toward the charging indicator light CHG until a "click" sound is heard.

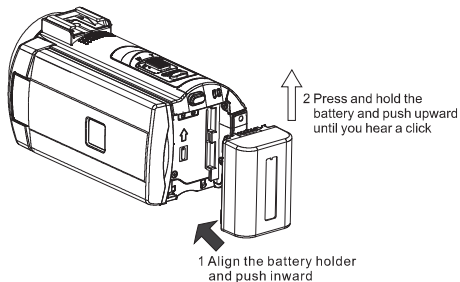

It is prohibited to use unqualified battery.

Mount the battery correctly, incorrect mount may damage the camera.

2.3 Charge the battery

2.3.1 Mount the battery, connect the camera and a USB charger. CHG indicator lights on indicates that is charging. When charging is completed, the indicator light turns off. It is recommended to turn off the camera, which will save charging time.

2.3.2 Specifications of charger: Output DC 5V/2A.

2.3.3 It can also be connected to a computer to charge the camera. Mount the battery, and connect the camera to the USB port of the computer with a USB cable. CHG indicator lights on indicates that is charging.

In order to shoot for long time, the camera can use the charger while recording videos. It is working only when charge the camera with a charger. And it's forbidden to use computer as power supply.



Please make sure the specifications of charger and power supply meet the requirements.

Please ensure ventilation and no coverage when charging. Remove the power supply immediately after charging is completed!

2 Preparation for use

2.4 Power on/off the camera

2.4.1 Short press <POWER/IR> to turn on the camera, long press <POWER/IR> to turn off the camera.

2.4.2 The camera has a sensor power on/off function. The camera automatically powers on when the left side cover with screen is unfolded, and powers off automatically when the left side cover with is closed.

2.4.3 When not in use for a long time, the camera will automatically shut down to save power.

2.5 Change working mode

The camera has three working modes-Photo mode/ Video mode/

Playback mode, press <MODE> to switch the working mode.

Video mode: The screen displays the " " icon, you can record a video.

Photo mode: The screen displays the " " icon, and you can take photos.

Playback mode: Play back photos/video files.

2.6 Use the Remote control

The camera can be operated with a remote control. When using the remote control, please aim at the remote control receiver of the camera, and there should be no objects between them.

The distance of remote control operation is not more than 6 meters.

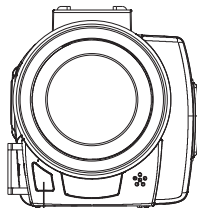

Remote receiver window



Before using the remote control, please remove the battery protection sheet of the remote control. Please aim the remote control at the remote control receiver, and do not block it.

2.7 Connect to a computer

The camera can be connected to a computer with a USB cable. Once connected, you can charging, file transmission, or use PC camera.

When the connection is successful, the screen displays options: "Mass storage/PC camera".

Choose Mass storage to use it as a USB flash drive.

Choose PC camera to use it as a computer camera.



If choose "PC camera", you need to download the corresponding software.

2.8 Connect to a TV

The camera can be connected to a TV via a HD cable.

2.8.1 Connect the HD output port in of the camera and the TV by a HD cable.

2.8.2 Operate on the TV, switch the signal input of the TV to the HD output port where the camera is connected. Camera content will be displayed simultaneously on the TV.

2 Preparation for use

2.9 Use an external microphone (Optional paid accessories, not included in the standard accessories)

Using an external microphone can effectively improve the sound quality and obtain good recording effects.

2.9.1 Install the external microphone and lock the nut according to the diagram.

2.9.2 Insert the microphone plug into the camera MIC interface and turn on the microphone switch.



Output impedance of the external microphone: $0.2K\Omega\sim 2.2K\Omega$. Due to differences in microphone parameters, please choose carefully and use them after matching.

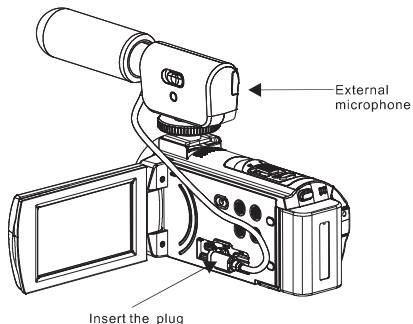

2.10 Use the Zoom function

The camera has a digital zoom function. In Video or Photo mode, slide the <W/T> to T to zoom in on the object, and slide the <W/T> to W to zoom out.

2.11 Use the IR night vision

The camera has infrared night vision function and can be used in dark environments. Night vision mode can only take photos or videos in black and white.

In video or photo mode, short press <POWER/IR> to turn on infrared night vision, and the screen will display in black and white.

2.12 Use the LED light

The camera has a LED light function that can compensate for light in darker environments.

In video or photo mode, short press <POWER/IR> twice to turn on the LED light, and press it again to turn it off.

3 Use the camera

This chapter helps you use the advanced functions of the camera.

3.1 Video mode

This mode is used to record videos, and you can also set parameters. All operations in this chapter are performed in Video mode. In Video mode, the screen displays some icons as follows:

1 Video mode	2 Loop recording	3 EV
4 Video resolution	5 Recordable time of video	6 W/T
7 Audio recording	8 Battery level	9 Time
10 Date	11 Night vision	

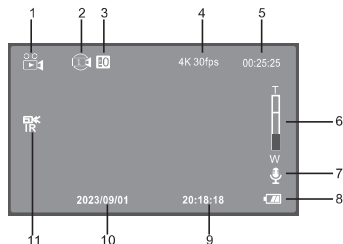

3.1.1 Record a video

3.1.1.1 Power on the camera and enter the video mode.

If the camera is in other modes, press <MODE> to change to video mode.

3.1.1.2 Hold the camera steadily and adjust the direction of the camera. Press <REC> to start recording. The red icon will flash. Press <REC> again to stop recording. During video recording, press <PHOTO> to pause, and then press <PHOTO> to resume recording.

3.1.2 Resolution

High resolution can capture better picture quality. But the higher the resolution, the larger the video file and the more storage space it takes up.

3.1.2.1 In video mode, press <MENU> to enter the menu.

3.1.2.2 Press <UP>/<DOWN> to choose "Resolution" in the list, and press <OK> to enter the options.

3.1.2.3 Press <UP>/<DOWN> to select the resolution you want, press <OK> to save, and press <MENU> to abandon. The operations in the following functions are the same.

This function can be operated by touch:

3.1.2.4 Tap the blank area on the screen to pop up the icon, and click "⌘" to pop up the menu.

3.1.2.5 Click the "Resolution" option, click the required option, the camera will automatically save and return.

3.1.2.6 Click the "↩" icon to return to video mode.

The following functions in this section support touch operations, and operation methods are the same as 3.1.2.

3 Use the camera

3.1.3 EIS

Turning on EIS can effectively eliminate image shake.

3.1.3.1 Press <UP>/<DOWN> to choose "EIS", and press <OK> to enter the options.

3.1.3.2 Press <UP>/<DOWN> to choose: Off/On, press <OK> to confirm.

 Once EIS is turned on, 5K/25fps resolution cannot be chosen.
Once EIS is turned on, the <W/T> zoom function cannot be used.

3.1.4 Color

Use special color effects.

3.1.4.1 Press <DOWN> to select "Color", press <OK> to enter the options.

3.1.4.2 Press <UP>/<DOWN> to choose, press <OK> to confirm.

3.1.5 Loop Recording

Loop recording means that when the memory card is full, the camera continues to record, and new videos automatically overwrite old videos (starting from the earliest file).

Use this function to turn on or off loop recording and adjust the length of each video.

3.1.5.1 Press <UP>/<DOWN> to select "Loop Recording" and press <OK> to enter the options.

3.1.5.2 Press <UP>/<DOWN> to choose, press <OK> to confirm. When a time option is selected, loop recording be turned on.

 Once loop recording is turned on, new videos will overwrite old videos.
Please save important files in time.

3.1.6 Slow Motion

Slow motion recording is suitable for shooting fast-moving scenes, such as running rabbits.

3.1.6.1 Press <UP>/<DOWN> to select "Slow Motion", and press <OK> to enter the options.

3.1.6.2 Press <UP>/<DOWN> to choose. Select "1080P 60fps" or "720P 60fps" to start slow motion recording.

3.1.7 Time-lapse Record

Time-lapse is a time-compressed shooting technology that compresses a process of several hours or longer into a shorter video. It is suitable for shooting slowly changing scenery, such as the process of flowers blooming.

3.1.7.1 Press <UP>/<DOWN> to select "Time-lapse Record", and press <OK> to enter the options.

3.1.7.2 Press <UP>/<DOWN> to choose; press <OK> to save, press <MENU> to abandon.
If "5 seconds" or other values is selected, time-lapse will be enabled.

3 Use the camera



Loop Recording, Slow Motion and Time-lapse Record cannot work at the same time. After turning on the special recording mode, you need to press <REC> to make the camera work in the specified mode.

3.1.8 White Balance

Adjust the white balance of the image according to the light source environment. Auto is recommended.

3.1.8.1 Press <UP>/<DOWN> to select "white balance", and press <OK> to enter the options.

3.1.8.2 Press <UP>/<DOWN> to choose, press <OK> to confirm.

3.1.9 Sharpness

Adjust the sharpness of the video to make the edges of the image clearer or softer.

3.1.7.1 Press <UP>/<DOWN> to select "Sharpness" and press <OK> to enter the options;

3.1.7.2 Press <UP>/<DOWN> to choose:, press <OK> to confirm.

3.1.10 Exposure

Adjust the EV (Exposure Value) according to the environment. The higher the EV value, the brighter the video.

3.1.5.1 Press <UP>/<DOWN> to select "Exposure" and press <OK> to enter the options;

3.1.5.2 Press <UP>/<DOWN> to to choose the EV value.



When the ambient brightness is low, this function does not work.

3.1.11 WDR

Turn on WDR (wide dynamic range) to shoot clear videos in places with strong contrast between light and dark.

3.1.11.1 Press <UP>/<DOWN> to select "WDR", and press <OK> to enter the options.

3.1.11.2 Press <UP>/<DOWN> to choose: Off/On.

3.1.12 Record Audio

Turn on or off the sound during recording.

3.1.12.1 Press <UP>/<DOWN> to select "Record Audio" and press <OK> to enter the options.

3.1.12.2 Press <UP>/<DOWN> to choose: Off/On.



When Slow Motion or Time-lapse Record is enabled, the Record Audio is turned off by default and this setting does not work.

3 Use the camera

3.1.13 Date Stamp

Set whether the video displays time and date watermarks.

3.1.13.1 Press <DOWN> to select "Date Stamp" and press <OK> to enter the options.

3.1.13.2 Press <UP>/<DOWN> to choose: Off/On, press <OK> to save.

3.1.14 Light Metering

Set the camera's light metering mode.

3.1.14.1 Press <DOWN> to select "Light Metering" and press <OK> to enter the options.

3.1.14.2 Press <UP>/<DOWN> to choose, press <OK> to confirm.

3.2 Photo mode

This mode is used to take photos and various parameters can be set to help take beautiful photos. If you are not familiar with this camera, it is recommended to use the default settings.

The default is Video mode when power on the camera, press <MODE> to change to photo mode, the screen displays some icons as shown below:

1 Photo mode	2 Self timer	3 Sequence shoot
4 EV	5 Image Resolution	6 number of available photos remaining
7 W/T	8 Battery level	9 Time
10 Date	11 Night vision	

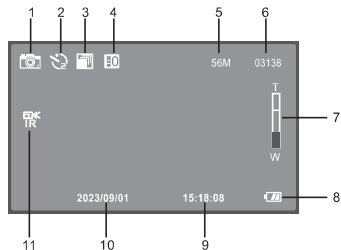

3.2.1 Take photo

3.2.1.1 Press <MODE> to change to photo mode, and the camera icon will be displayed on the screen.

3.2.1.2 Aim the lens at the scene, adjust the angle and orientation, hold the camera tightly and keep it steady.

3.2.1.3 Press lightly <PHOTO> and the focus frame will be displayed on the screen. Press hard <PHOTO>, and then you will hear a "click" sound when the photo taking is completed.

3.2.2 Resolution

Set the resolution of the photo. The higher the resolution, the larger the file size and the more storage space it takes up.

3 Use the camera

3.2.2.1 Press <MENU> to enter menu, press <UP>/<DOWN> to select "Resolution", press <OK> to enter the options.

3.2.2.2 Press <UP>/<DOWN> to choose photo resolution, press <OK> to save, press <MENU> to abandon. The operations in the following functions are the same.

This function can be operated by touch:

3.2.2.3 Tap the blank area on the screen to pop up the icon, and click "⌂" to pop up the menu.

3.2.2.4 Click the "Resolution" option, click the required option, the camera will automatically save and return.

3.2.2.5 Click the "↩" icon to return to video mode.

The following functions all support touch operations, and the operation methods are the same as 3.2.2.

3.2.3 White balance

Adjust and correct the white balance of the picture according to different light source environments. Auto is recommended.

3.2.3.1 Press <UP>/<DOWN> to select "White Balance", press <OK> to enter the options.

3.2.3.2 Press <UP>/<DOWN> to choose, press <OK> to save.

3.2.4 Quality

Set the quality of the photo. The higher the quality of the photo, the more storage space it will take up.

3.2.4.1 Press <UP>/<DOWN> to select "Quality", press <OK> to enter the options.

3.2.4.2 Press <UP>/<DOWN> to choose, press <OK> to save.

3.2.5 Sharpness

Set the sharpness of the photo to make the edges of the photo sharper or softer.

3.2.5.1 Press <UP>/<DOWN> to select "Sharpness", press <OK> to enter the options.

3.2.5.2 Press <UP>/<DOWN> to choose, press <OK> to save.

3.2.6 Selftimer

Set the waiting time when taking a selfie.

3.2.6.1 Press <UP>/<DOWN> to select "Selftimer", press <OK> to enter the options.

3.2.6.2 Press <UP>/<DOWN> to choose the Selfie time.

3.2.7 Color

Use special color effects while taking pictures.

3.2.7.1 Press <DOWN> to select "Color", press <OK> to enter the options.

3.2.7.2 Press <UP>/<DOWN> to choose, press <OK> to save.

3.2.7.3 Press <OK> to save, press <MENU> to return.

3 Use the camera

3.2.8 ISO

Set the photo sensitivity, auto is recommended.

3.2.8.1 Press <DOWN> to select "ISO", press <OK> to enter the options.

3.2.8.2 Press <UP>/<DOWN> to choose , press <OK> to save.

3.2.9 Exposure

Adjust the exposure of the photo, the larger the EV value, the brighter the photo, otherwise the darker the photo.

3.2.9.1 Press <DOWN> to select "Exposure", press <OK> to enter the options.

3.2.9.2 Press <UP>/<DOWN> to choose , press <OK> to save.



The function does not work when the ambient brightness is low.

3.2.10 Sequence

Turn on this function, when user press <PHOTO>, the camera will take three photos continuously.

3.2.10.1 Press <DOWN> to select "Sequence", press <OK> to enter the options.

3.2.10.2 Press <UP>/<DOWN> to choose, press <OK> to save.

3.2.11 WDR

Turn on WDR (Wide Dynamic Range) to take clearer photos in places with strong contrast of light and shade.

3.2.11.1 Press <DOWN> to select "WDR", press <OK> to enter the options.

3.2.11.2 Press <UP>/<DOWN> to choose WDR: Off/On, press <OK> to save.

3.2.12 Light Metering

Set the metering mode of the camera.

3.2.12.1 Press <DOWN> to select "Light Metering", press <OK> to enter the options.

3.2.12.2 Press <UP>/<DOWN> to choose, press <OK> to save.

3.2.13 Date Stamp

Set whether to display time and date stamps on photos.

3.2.13.1 Press <DOWN> to select "Date Stamp", press <OK> to enter the options.

3.2.13.2 Press <UP>/<DOWN> to choose, press <OK> to save.

3 Use the camera

3.3 Playback Mode

Photos and videos shot by the camera can be viewed in playback mode, and operations such as deletion can also be performed.

Press <MODE> twice in video or photo mode to enter playback mode, and press <MODE> again to exit.

3.3.1 Play back a video or photo

3.3.1.1 Press <UP>/<DOWN> to choose a video or a photo.

3.3.1.2 Press <UP>/<DOWN> to choose a video, press <OK> to start playing. During video playing:

Press <REC> or <OK>: Pause/Resume playing; Press <MENU>: Stop playing

Press <UP>: Rewind, press <DOWN>: Fast forward

Move <W/T> to T: Turn Up the sound, move <W/T> to W: turn Down the sound

3.3.2 Delete files.

Delete one or more files.

3.3.2.1 Press <MENU> to enter the menu.

3.3.2.2 Press <UP>/<DOWN> to select the file, and press <OK> to enter the options: Delete Current/Delete All.

3.3.2.3 Press <OK> to pop up a dialog box, press <UP>/<DOWN> to choose: Cancel/OK.

3.3.2.4. Press <OK> to execute and return, press <MENU> to abandon.



Deleted files cannot be recovered, so please proceed with caution.
Locked files can be deleted only after they are unlocked.

3.3.3 Protect

Protect video or photo files, remove file protection.

3.3.3.1 Press <MENU> to enter the menu.

3.3.3.2 Press <UP>/<DOWN> to select "Protect", press <OK> to pop up a dialog box:

Lock Current/Unlock Current/Lock All/Unlock All.

3.3.3.3 Press <UP>/<DOWN> to choose, press <OK> to execute, press <MENU> to abandon.

In playback mode, touch operation is available.

Please click the corresponding icon or menu on the screen to complete the operation.

4 System Menu

Set system parameters such as Date&Time, Language, Beep Sound, Light Metering, etc.

In video or photo mode, press <MENU> twice to enter the System Menu, as shown below:

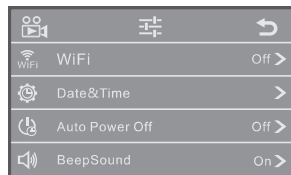

4.1 WiFi

Turn Wi-Fi on or off.

4.1.1 In system menu, press <UP>/<DOWN> to select "WiFi", and press <OK> to enter the options.

4.1.2 Press <UP>/<DOWN> to choose: Off/On, press <OK> to save, press <MENU> to abandon.

4.2 Date&Time

Set the system date and time.

4.2.1 Press <UP>/<DOWN> to select "Date & Time", and press <OK> to enter options.

4.2.2 The cursor stops on "Year", press <UP>/<DOWN> to adjust the number, press <OK> to move to "Month", and adjust the number. Follow this method to complete the "Day"/"Hour"/"Minute"/"Second" settings in sequence.

4.2.3. Press <OK> to save and return.

4.3 Auto Power Off

Turn on the auto power off function. When the camera is not used for a certain period of time, it will automatically power off to save power.

4.3.1 Press <DOWN> to select "Auto Power Off", press <OK> to enter the options.

4.3.2 Press <UP>/<DOWN> to choose, press <OK> to save and return.

4.4 Beep Sound

Set button sound on or off.

4.4.1 Press <UP>/<DOWN> to select "Beep Sound", and press <OK> to enter the options;

4.4.2 Press <UP>/<DOWN> to choose: On/ Off, and press <OK> to save and return.

4 System Menu

4.5 Language

Select the system language.

4.5.1 Press <UP>/<DOWN> to select "Language Settings", and press <OK> to enter the options.

4.5.2 Press <UP>/<DOWN> to choose a language, and press <OK> to save and return.

4.6 Frequency

Set the light source frequency to avoid the image flickering under the light. Please refer to the local power supply standards.

4.6.1 Press <UP>/<DOWN> to select "Frequency", and press <OK> to enter the options.

4.6.2 Press <UP>/<DOWN> to choose, press <OK> to save and return.

4.7 WiFi Auto Off

Set the time for the camera to automatically turn off Wi-Fi when Wi-Fi is turned on but the phone is not connected.

4.7.1 Press <UP>/<DOWN> to select "WiFi Auto Off", and press <OK> to enter the options.

4.7.2 Press <UP>/<DOWN> to choose, press <OK> to save and return.

4.8 Format

Format the memory card. Performing a format will delete all files and cannot be recovered.

4.8.1 Press <UP>/<DOWN> to select "Format", and press <OK> to enter the options.

4.8.2 Press <UP>/<DOWN> to choose: Cancel/OK.

4.8.3 Choose "OK", please wait, it will return automatically when the execution is completed.



Formatting will delete all files, and files cannot be recovered after deletion, please use with caution.

4.9 Default Setting

If wrong settings cause the camera to work abnormally, use this function to restore the camera to the factory default settings.

4.9.1 Press <UP>/<DOWN> to select "Default Setting", press <OK> to enter the options.

4.9.2 Press <UP>/<DOWN> to choose: Cancel/OK. Press <OK> to execute, press <MENU> not to abandon.

4.10 Version

Check the firmware version of the camera.

Press <DOWN> to select "Version", press <OK>, the screen will display the current firmware version information of the camera. Press <OK> again to exit.

5 Wi-Fi Connection

The camera's Wi-Fi can be connected to a mobile phone, but cannot access the Internet.

5.1 In video or photo mode, long press <MENU> for 3 seconds to turn on Wi-Fi. The screen will display: AP mode.

5.2 Turn on the mobile phone's Wi-Fi and search for Wi-Fi devices. Find the camera Wi-Fi name in the list: HDV_x x x x x x x x x x. Click and enter the device password "12345678" and wait for the connection to be completed. After completion, open the mobile APP and you can use it.

5.3 After use, long press <MENU> for 3 seconds or short press <OK> to turn off Wi-Fi.

Wi-Fi has been enabled.

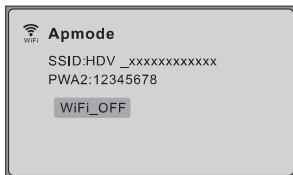

The Wi-Fi has been connected to the phone



The camera Wi-Fi can only be connected to a mobile phone and cannot access the Internet.

6 Appendices

6.1 Technical Specifications

Image sensor	CMOS sensor, Max 56.0MP (Interpolation)
Storage medium	Supports memory card, up to 256GB (U3 speed or above)
ISO	Auto, ISO100, ISO200, ISO400, ISO800, ISO1600, ISO3200, ISO6400
Lens	Fixed: F:2.0, f=2.9mm; focusing distance: 0.4m~infinity
Photo	Format: JPG. Resolution: 5M/8M/12M/16M/20M/24M/36M/48M/56M (Interpolation)
Video	Format: MP4 5K/25fps, 4K/30fps, 2.7K/30fps, 1080P/60fps, 1080P/30fps, 720P/60fps, 720P/30fps
Zoom	18X digital zoom
Anti-shake	EIS
IR Night vision	Support
White balance	Auto/Sunny/Cloudy/Tungsten/Fluorescent
EV	-3.0EV ~ +3.0EV
Computer port	USB Type-C
LCD screen	3.0 inch IPS touch screen
Microphone	Built-in, support External MIC
Speaker	Built-in
HD output	Support
Wi-Fi	Support, the mobile phone and the camera end-to-end connection (Can't access the internet)
IR remote control	Support, ≤6 meters
Battery	lithium battery NP-180

6 Appendices

Power source	DC 5V/2A
Language	English/French/Spanish/Portuguese/German/Italian/Simplified Chinese/Traditional Chinese/Russian/Japanese
Dimensions	117 (L)×57 (W)×61 (H) mm
Weight	About 250±5g (excluding battery)

6.2 Common faults and solutions

Problem	Possible cause	Solution
Can not turn on the camera	Battery mount incorrectly or Battery low	Mount the battery correctly or Charge the battery
Suddenly black screen	Auto Power Off is on or Battery low	Restart or Charge the battery
Can't record video or take photos	Memory card not formatted	Format the memory card
	Memory card speed is too slow	Replace the memory card with U3 or above
	Memory card write protection	Remove write protection
Recording anomaly	Time-lapse Record or Slow Motion is on	Turn off the function
Photos are not clear	Lens is dirty or has foreign matter.	Clean the lens with a special soft cloth and keep it clean
Prompt memory card error	Memory card write protection	Release memory card write protection
	Memory card format error or Memory card is damaged	Format the memory card or replace a new memory card
Freeze at work	Memory card is not qualified	Replace with a qualified memory card

6 Appendices

Problem	Possible cause	Solution
Photos/videos are out of color	Wrong settings of camera parameters such as White Balance/Color/Exposure	Set parameters correctly. Reset to factory settings (Default setting).
Remote control does not work	Remote receiver window is blocked.	Remove the blocking object
	Battery is low power	Replace the battery
	The distance is too far	Stay close to the camera when using it.
External microphone works abnormally.	No battery or low power	Insert a battery with sufficient power.
	Wrong microphone parameters or Wrong connection	Select a microphone with the correct parameters or Connect it correctly.
Connection to the computer is abnormal	Wrong connection or Damaged USB cable	Correctly connect or Replace the USB cable
Video freezes when playing on computer	Computer configuration is too low	Use a computer that meets the requirements. Copy the files to your computer for playback.
Wi-Fi distance is short	There may be electromagnetic interference in the environment	Use in places with little electromagnetic interference
Wi-Fi is intermittent	There may be electromagnetic interference in the environment	Use in places with little electromagnetic interference
Playing video freezes in the APP	The video file is too large and takes a long time to buffer	Download the video to the local album and play it

SHENZHEN PA. TIMES TECHNOLOGY CO., LTD

E-mail: service@ordro.cn

Http: [//www.ordro.cn](http://www.ordro.cn)