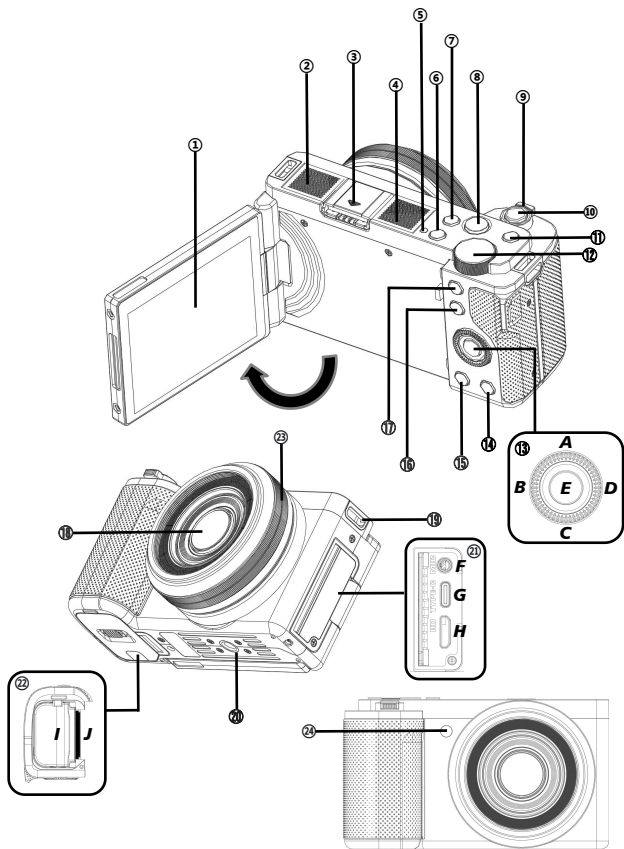

Table of Contents

• Component Introduction	1
• Loading Battery & Charging	3
• Using a Memory Card.....	3
• Photo.....	4
• Video.....	5
• PlayBack.....	6
• System Settings.....	7
• APP.....	8
• Q&A.....	9
• Faults And Solution.....	9
• Technical Specifications	10

Component Introduction



①	IPS Touch Panel	Screen preview and video/photo playback	
②	Microphone	Recording sound	
③	Hot Shoe Interface	Mount hot shoe products	
④	Speaker	Play sound	
⑤	State Light	Green light always on: Standby; Green light continuously flashing: In the recording; Green light flashes once: take a photo; Red light always on: During charging, it turns off when fully charged	
⑥	POWER Button	Power On/Off	
⑦	DISP Button	Press to switch screen display mode	
⑧	VIDEO Button	START/STOP recording	
⑨	T/W Zoom Button	In video/Photo Mode, pull left/right to zoom in/out; In playback, pull left to switch to grid preview	
⑩	PHOTO Button	Two-stage button, tap to focus and press to photo in photo mode	
⑪	MODE Button	Call up Shooting Modes list	
⑫	Adjusting knob	In P (Program Auto) mode: Adjust exposure; In S (Shutter Priority) mode: adjust the shutter speed; In Video mode: adjust exposure; In SCN (Scene Selection) mode: select the scene; In Macro mode: Adjust exposure	
⑬	A	Drive Mode Button	In standby : enter the burst/self-timer option; In the function menu: Select the function upwards
	B	AE-L Button	In standby : Lock the current exposure value; In the function menu: Select function to the left
	C	Exposure Button	In standby: enter the exposure value option; In the function menu: Select the function downwards
	D	AFL Button	In standby: lock the current focus; In the function menu: select the function to the right
	E	Confirm Button	In standby : enter the effects, contrast, Image tone , saturation, Hue and sharpness options; In the function menu: Confirm the selection of functions; In playback mode: start/pause playback
⑭	Delete Button	Delete recent files.	
⑮	PLAYBACK Button	Enter the playback mode	
⑯	Fn shortcut function Button	Enter the shortcut function menu	
⑰	MENU Button	In standby: enter the function menu; playing a video: stop playing	
⑱	Lens	Framing	
⑲	Strap Mounting Hole	Install adjustable strap	
⑳	1/4 Tripod Socket	Tripod installation	
㉑	F	MIC Interface	Access to external microphones
	G	TYPE-C USB Interface	External USB cable
	H	HD interface	External HDMI cable
㉒	I	Battery Compartment	Load Battery
	J	SD slot	Insert the SD Card
㉓	Manual focusing wheel	Manually focus in MF mode	
㉔	AF auxiliary light	Auxiliary focusing	

Loading Battery & Charging

• Loading the battery

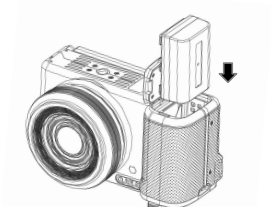

【Install the battery into the camera in the direction shown in the diagram】

• Battery charging

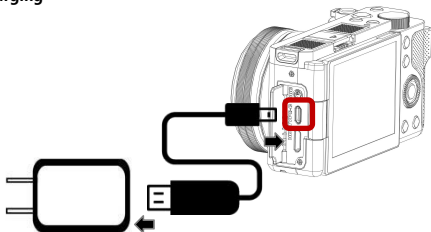

Using a Memory Card

• Inserting a memory card

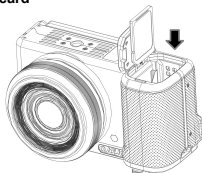

【Insert the memory card straight in the direction shown in the diagram】

- ! When using the memory card for the first time, please be formatting on the camera.
- A U3 512GB memory card is recommended, and any memory card below U3 may not function properly.

Photo

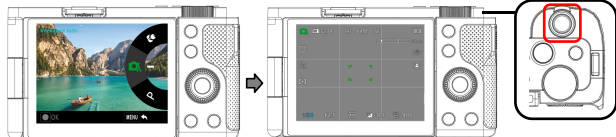

【Press the **MODE Button** to select the Shooting Modes】

【Hold the camera firmly, lightly press (half press) **Photo button** to focus, then heavily press (full press) the **Photo button** again to take a photo】

● Photo function menu

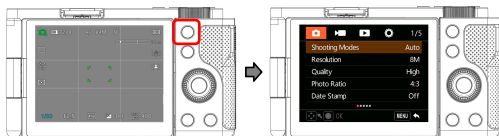

【Press the **MENU Button** to enter the function menu】

Shooting Modes	Intelligent Auto/Program Auto/Shutter Priority/Video/Scene Selection/Macro
Resolution	64M/56M/48M/36M/30M/20M/14M/10M/8M/5M/3M/2M
Quality	SF/F/N
Photo Ratio	4:3/16:9
Date Stamp	Off/Date/Date&Time
Focus Modes	AF/MF/AF+MF/AF+MF2
Real time focusing	Off/On
Face tracking	Off/On
AF Assist Lamp	Off/Auto
White Balance	Auto/Daylight/Cloudy/Tungsten Light/Fluorescent(H)/Fluorescent(L)/Color Temperature
Filter Style	Standard/Natural/Vivid/Monotone/High Contrast B&W/Negative/High Contrast/Retro/CCD/Warm Colors/Cold Colors/Red Tone/Green Tone/Blue Tone/Yellow Tone
Soft Skin Effect	Off/Low/High
Exposure Compensation	-3.0 ~ +3.0
ISO	Auto/100/200/400/800/1600/3200
Metering Modes	Average/Center/Spot
Flash Mode	Off/On (External flash is required before use)
Drive Modes	Single Shootings/Continue Shootings:3/Continue Shootings:5/Continue Shootings:7/Self-timer:2 sec/Self-timer:5 sec/Self-timer:10 sec
Interval Timer Shooting	Off/3 Sec/5 Sec/10 Sec/30 Sec/1Min
Interval Mode Duration	Unlimited/5 Min/10 Min/15 Min/20 Min/30 Min/60 Min
Image Stabilization	Off/On

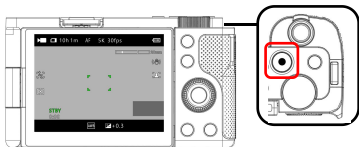

【 Press the **VIDEO Button** to start/stop recording 】

● Video function menu

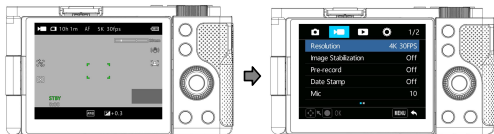

【 Press the **MENU Button** to enter the function menu in Video mode 】

Resolution	5K30/4K60/4K30/2.7K60/2.7K30/1080P60/1080P30/720P60/720P30
Image Stabilization	Off/On
Pre-record	Off/On
Date Stamp	Off/Date/Date&Time
Mic	1 ~ 20
Slow Motion	Off/1080P 2X/720P 2X
Loop Record	Off/1 Min/3 Min/5 Min
Time-Lapse Video	Off/1 Sec/3 Sec/5 Sec/10 Sec/30 Sec/1 Min
Duration	Unlimited/5 Min/10 Min/15 Min/20 Min/30 Min/60 Min

PlayBack



【Press the **PLAYBACK Button** while in standby】



【Press **CONFIRM Button** to play the video】



【Press the **AEL** and **AFL Buttons** to switch file browsing;
Press the **MENU Button** to enter the function menu】

Delete	Single/All
Protect	Protect this file/Unprotect this file/Protect all/Unprotect all
Slide Show	2 Sec/5 Sec

System settings



【Press the **MENU Button** to enter the function menu 】



【Press the **EXPOSURE Button+AFL Button** to adjust and enter the system settings menu 】



Wi-Fi	Off/On
Grid Line	Off/White Line/Yellow Line/Red Line
Fixed focal length	Off/16mm Focal length/24mm Focal length/35mm Focal length/ 50mm Focal length/80mm Focal length
Sounds	Shutter/Boot-up/Beep/Volume
Date&Time Setup	Date&Time Settings
Time Style	YYMMDD/MMDDYY/DDMMYY
Language	13 Languages
Screen Brightness	Low/Middle/High
Screen Saver	Off/1 Min/2 Min/3 Min
Auto Power Off	Off/5 Min/10 Min
Light Frequency	50HZ/60HZ
Format Card	Yes/No
Factory Reset	Yes/No
Version	Current software version

APP

• Download And Install The App

- 1 Scan the QR code below to download and install directly on the phone.
- 2 Search and install "OD CAM" directly through the App Store or mobile app store.



• Connect Wi-Fi



【Turn on the **Wi-Fi** function in the system settings menu and wait for the phone to connect】

【Wi-Fi Name: **G630-XXXX**
Wi-Fi Password: **12345678**】

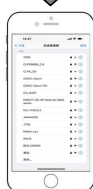

【Click on **OD CAM** to enter】

【Find **G630-XXXX** in your phone's Wi-Fi settings
And enter the password to connect】

- ! For Android users, please select [Yes] for all possible questions like [Allow the App to obtain the permission?]
- The Wi-Fi function is point-to-point wireless connection within effective distance. The maximum distance is about 6m. Please use the function within the effective distance.
- Because of various phone brands or configurations, the process to enter the main interface may be slow or the connection may fail. Please try the connection process again.

Q1: A video may be automatically divided into several files. How can I combine them into one?

A1: You can combine them by using a video combiner in your computer. You may search [Boilsoft Video Joiner] on Google.com to download it .

Q2: Which operating systems or mobile phones is the App compatible with?

A2: The App is compatible with the following operating systems:

Android: Android 5.0, Android 6.0, Android 7.0, Android 8.0,

Android 9.0, Android 10.0, and Android 11.0;

iOS: iOS 9, iOS 10, iOS 11, iOS 12, iOS 13, , iOS 14 and iOS 15;

Regardless of the systems it is compatible with, the stability of the App depends on the configurations of the phone as well as network conditions. The App is not Applicable to computers.

Q3: Why does my Android phone always fail in connecting to the App?

A3: After successfully connecting your phone to the Wi-Fi, please select [Yes] in case it prompts [Wi-Fi is not connected to the Internet. Will you continue using it?]

Faults And Solution

Fault	Possible Cause and Solution
Failure to switch on	<ul style="list-style-type: none"> ●The Camera has low battery. Please recharge it immediately. ●Check whether the operating environment temperature is within 0~40°C.
Failure to switch off	<ul style="list-style-type: none"> ●If the ambient temperature is high or the Camera is used for an extended period, it may have excessively high temperature. Please wait a moment .
Automatic shutdown	<ul style="list-style-type: none"> ●It's normal that the Camera automatically shuts down after standing by for three minutes. ●Check whether the operating environment temperature is within 0~40°C. ●If the Camera is used for an extended period, it may have excessively high temperature. Please wait a moment and switch it on after it cools down.
Rapid battery drain	<ul style="list-style-type: none"> ●Battery performance degrades in low temperature. Please use it after it is preheated. ●The battery is not fully charged. Please recharge it. ●The battery is reaching the end of its usable life, please buy a new battery.
Wi-Fi signals are unstable	<ul style="list-style-type: none"> ●The distance is too long. Please use it within 6m (effective distance). ●The Camera has low battery. Please recharge it immediately. ●The wireless signals are interfered because the Camera is placed on a metal table or stand. Keep it away from metal. ●The Wi-Fi signals of the phone are weak. Please use another phone.
Video voice is too low	<ul style="list-style-type: none"> ●The sound equipment is poor or the volume is not properly adjusted. Please use other equipment or adjust the volume. ●The distance to the sound source is too long. Please record your videos within 5m (effective distance).

Technical Specifications

Sensor	Sony 8.0MP CMOS sensor
Aperture and focal length	F.no 1.96 ~ 3.64 f : 2.38mm~11.9mm
Lens thread diameter	49mm
Screen	3.2"IPS High -Definition touch screen
Zoom	5X Optical zoom 15X Hybrid zoom
Photographing distance	Wide: 0.15m~INF Tele: 0.4m~INF
File format	Video: MP4 Photo: JPEG
Video Resolution	5K30/4K60/4K30/2.7K60/2.7K30/1080P60/1080P30/720P60/720P30
Photo Pixel	64M/56M/48M/36M/30M/20M/14M/10M/8M/5M/3M/2M
Memory medium	SDHC memory card/SDXC memory card UHS-III,512GB (maximum)
Microphone	Built-in
Speaker	Built-in
Wi-Fi	Built-in
USB	Type-C USB 2.0
HDMI	Built-in
Hot Shoe	Built-in
Computer OS	Windows 7/8/10/11 Mac OSX10.5 and above
Mobile OS	Android 5.0 and above; iOS 9.0 and above
Power input	DC5V/2A Type-C USB
Dimensions	L 117mm W 60mm H 66mm
Weight	290±5g(Excluding battery)
Working temperature	0 ~ 40℃

Safety	Warning
<ul style="list-style-type: none"> ❶ Do not use the product in case it has any damage, fault, or unusual conditions like smoke, abnormal sound, peculiar smell. ❷ Do not expose it to anywhere with high or low temperature, humidity, or strong vibration, for this may result in any fault or fire. ❸ Do not use any corrosive chemicals or solvent to clean the product. ❹ Do not disassemble, repair, or transform the product without authorization. ❺ Do not operate it for a long time while it's being charged. ❻ Do not let magnetic objects such as magnets Approach the product to avoid faults and data loss. 	<ul style="list-style-type: none"> ❶ Prevent dust or dirt from entering the slot and USB port. Promptly wipe off or remove them in case of such condition to avoid conditions like poor contact. ❷ Keep the product, accessories, and packing materials out of the reach of children to avoid possible suffocations. ❸ Do not use any USB cable other than the accessories. Use the USB cable specified only and pay attention to the followings: <ul style="list-style-type: none"> · Do not damage or process the USB cable. · Do not heat, pull, or bend the USB cable to avoid possible fire or electric shock.

The pictures in the manual are for your reference only. The actual product may vary.

We reserve the ultimate power of interpretation. Any changes to the data and parameters herein may be made without further notice.

This equipment has been tested and found to comply with the limits for a Class B digital device, pursuant to part 15 of the FCC Rules. These limits are designed to provide reasonable protection against harmful interference in a residential installation. This equipment generates, uses and can radiate radio frequency energy and, if not installed and used in accordance with the instructions, may cause harmful interference to radio communications. However, there is no guarantee that interference will not occur in a particular installation. If this equipment does cause harmful interference to radio or television reception, which can be determined by turning the equipment off and on, the user is encouraged to try to correct the interference by one or more of the following measures:

- Reorient or relocate the receiving antenna.
- Increase the separation between the equipment and receiver.
- Connect the equipment into an outlet on a circuit different from that to which the receiver is connected.
- Consult the dealer or an experienced radio/TV technician for help.

Caution: Any changes or modifications to this device not explicitly approved by manufacturer could void your authority to operate this equipment. This device complies with part 15 of the FCC Rules.

Operation is subject to the following two conditions:

- (1) This device may not cause harmful interference, and
- (2) this device must accept any interference received, including interference that may cause undesired operation. This equipment complies with FCC RF radiation exposure limits set forth for an uncontrolled environment. This device and its antenna must not be located or operating in conjunction with any other antenna or transmitter.



FCC ID: 2ALYUG630